

HiperPFS™ -5

- Integrated 750 V PowiGaN™ switch with lossless current sensing
- Up to 250 W output for universal applications without heatsink
- > 98.3% efficient from 10% load to 100% load
- As low as 38 mW no-load consumption at 230 VAC
- 0.96 PF at 20% load
- Integrated X-capacitor discharge and self-bias

Compact, High Efficiency PFC Controller with Integrated 750 V PowiGaN Switch

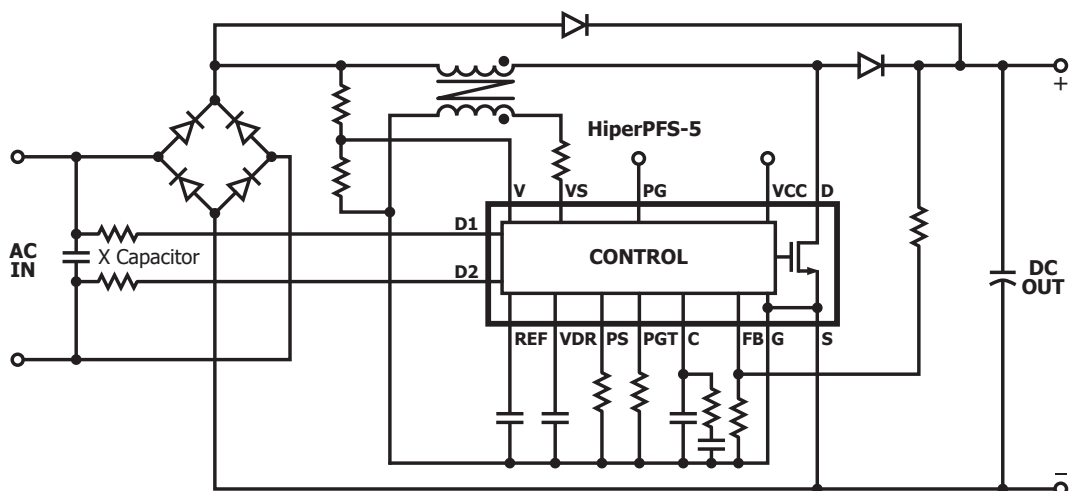

PI-9302b-110521

Applications

- PFC converters
- High-power adapters
- High-power LED lighting
- Industrial and appliances
- LCD TVs
- PCs
- Printers
- Video game consoles
- 80 Plus™ Platinum

Output Power

Universal Input Devices	
Part Number	Maximum Continuous Output Power (W) at 90 VAC
PFS5173F	77
PFS5174F	115
PFS5274F	115
PFS5175F	130
PFS5275F	130
PFS5176F	165
PFS5276F	165
PFS5177F	185
PFS5178F	250

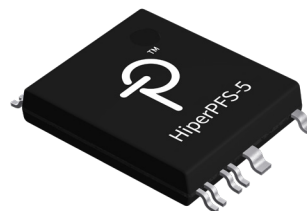

Package: InSOP™-T28F

Design Support

- Data Sheet** [HiperPFS-5 data sheet \(www.power.com/hiperpfs-5-data-sheet\)](http://www.power.com/hiperpfs-5-data-sheet)
- Design Example** [220 W, 24 VDC output LLC + CRM PFC power supply using HiperPFS-5 and HiperLCS-2 chipset \(DER-672\) \(www.power.com/der-672\)](http://www.power.com/der-672)
- Video** [Introduction to HiperPFS-5 \(www.power.com/hiperpfs-5-video\)](http://www.power.com/hiperpfs-5-video)